



Kitchen Installation Guide

Magnet

Better. By design

Contents

Introduction	page 2	Fitting plinths	page 14
Suggested tools required	page 4	Attaching to wall	page 15
Overall unit dimensions	page 5	Connecting units	page 16
Kitchen working dimensions	page 6	Fitting filler and end panels	page 16
Preparing the kitchen area	page 6	Starting a unit run from a wall	page 17
Adding datum line to the kitchen area	page 7-11	Handle fitting	page 17
Starting in a corner, base units	page 12	Cornice and pelmet fitting	page 17
Starting in a corner, wall units	page 13	Frontal fitting - Tamdembox	page 18
Attaching legs	page 14	Frontal fitting - Metabox	page 19

Introduction

Thank you for choosing our kitchen. It is important that you carefully read all of the instructions before starting installation.

Our kitchens have been created to display the materials to their best advantage and each individual material requires special consideration for storing, unpacking and cleaning.

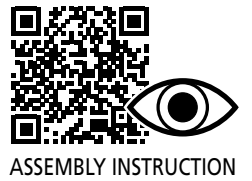

Storage of the products prior to installation

From the instance of manufacture, your new kitchen frontals, drawers, worktops and cabinets have been carefully packaged to ensure that you receive them in pristine condition.

Prior to installation, all the products for your new kitchen should be kept indoors in a safe, cool, dry location avoiding high humidity, extreme cold or heat sources. Always leave the product in it's original packaging.

Worktops should be stored horizontally on a sound and level surface. Do not store front edge down.

Do not remove the worktops from their packaging until the day of installation.

When removing the packaging, for your own safety and to protect the furniture, do not use sharp implements like utility knives.

Please help the environment and dispose of the packaging in a responsible manner.

Preparation

With all kitchens, ensure that the room where the product is to be installed has fully dried out following any wet trade work. (eg. plumbing and plastering). This work should be completed prior to installation with sufficient time allowed for natural drying.

Rooms with areas below ground level need to be fully tanked (sealed against ingress of moisture from the surrounding earth).

We recommend that competent kitchen fitters or joiners should undertake all cabinet installation work.

Electrical, gas and plumbing work

A registered electrician must undertake any electrical fitting work and the work must be verified.

Fitting of new or changed electrical points needs to be completed before installation of your new kitchen.

A registered Gas Safe fitter must carry out all work on gas installations.

Please refer to the manufacturer's guidelines before installing appliances.

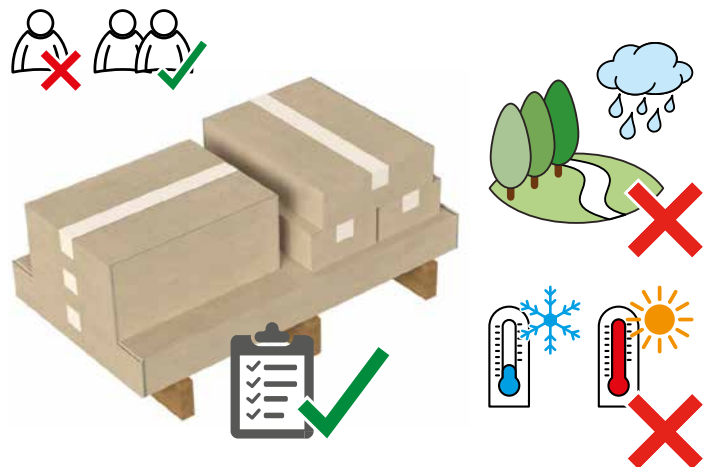

General information

All floor cabinets should be fitted to a solid, horizontal and flat surface eg. not on top of a carpet. When products have to be scribed or cut to fit during installation, please ensure that all raw edges are sealed.

Rooms should be well ventilated with an extractor fan if necessary. Extractor fans and appliances such as tumble dryers, water boilers and cooker hoods should be vented outside.

Important: Installation shall be carried out exactly according to the manufacturer's instructions otherwise a safety risk can occur if incorrectly installed.

Warning: In order to prevent cabinets overturning or falling down they must be used with the wall attachment device/s provided. Before fixing any cabinets to the wall, ensure the wall construction is capable of taking the weight of the loaded cabinet and that appropriate fixings are used. If in doubt, consult an expert.

Note: Wall fixing screws are not supplied due to different wall types requiring different fixings.

Care of Surfaces

Please refer to the separate Aftercare leaflet. Contact your local branch for the current version. These additional care instructions must be followed and it is advisable to keep a record of these instructions for future reference.

Warning: Never use an abrasive cleaning agent solvents or an aggressive or concentrated cleaner (even when described as an all/multi purpose cleaner) to clean your kitchen as they can damage the surfaces.

Warning: When oiling solid wood worktops as per the manufacturer's instructions, please ensure that the oil does not come into contact with any other product (such as frontals, sinks taps etc) as it will cause staining.

Note: Some products (eg. frontals and worktops) may have specific maintenance instructions provided from their manufacturer. If so, the individual products will be labelled appropriately.

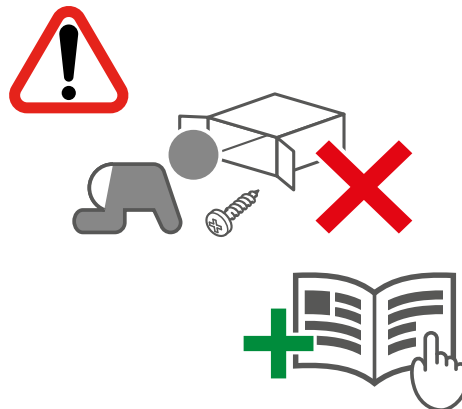

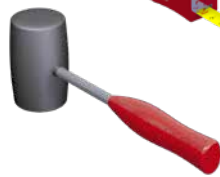

2.5mm
5mm
6mm
8mm
12mm



35mm





Dimensions based on
704mm Wall unit

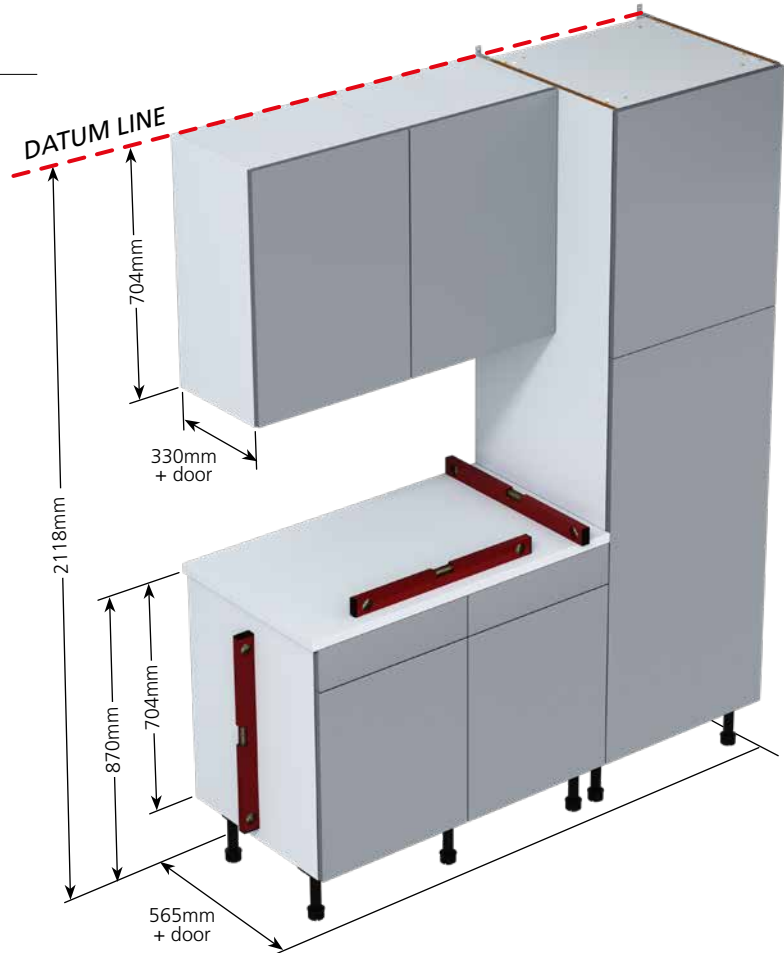

Dimensions based on
896mm Wall unit

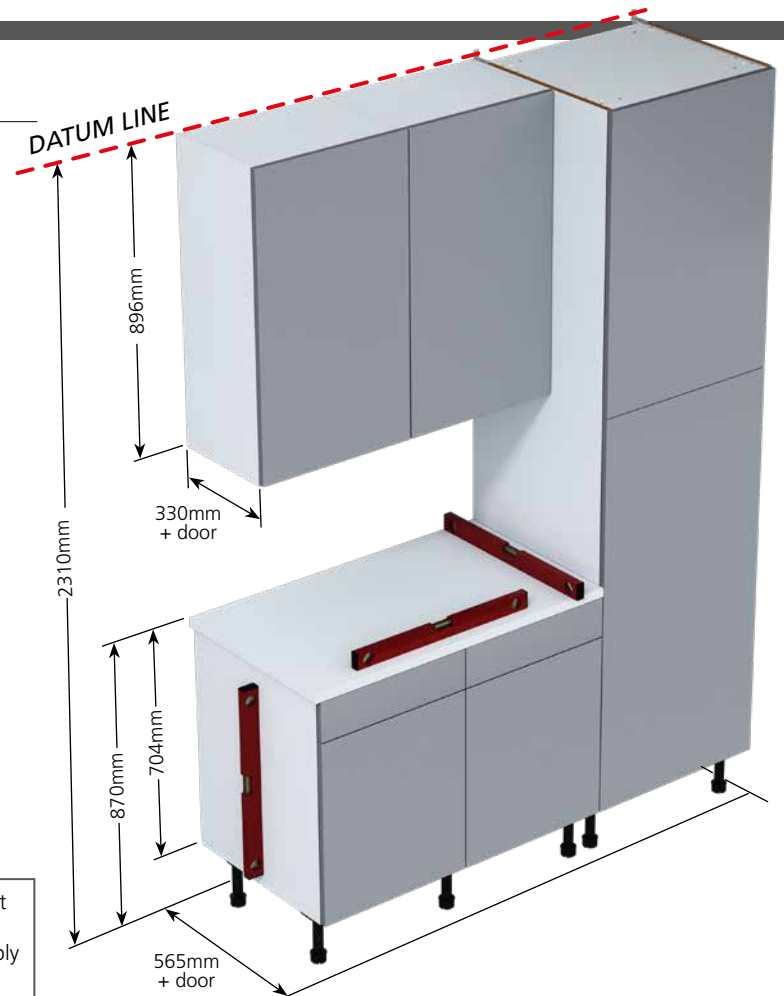

Note: All double wall units must be fitted with support brackets. Please refer to individual assembly instructions for details.

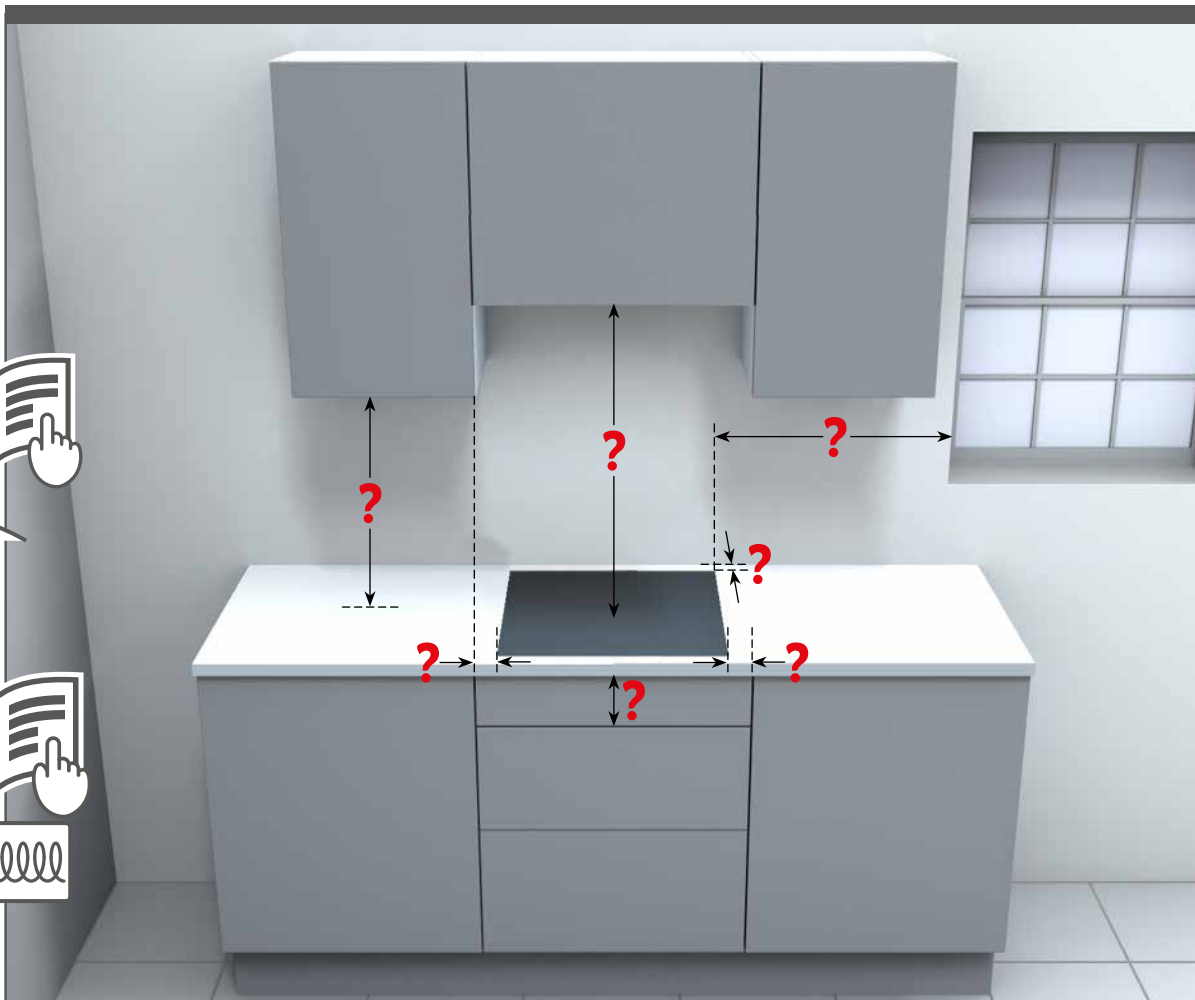
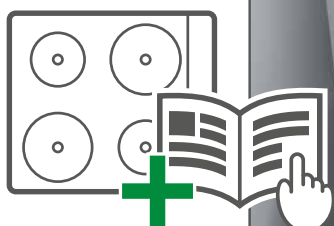

1a

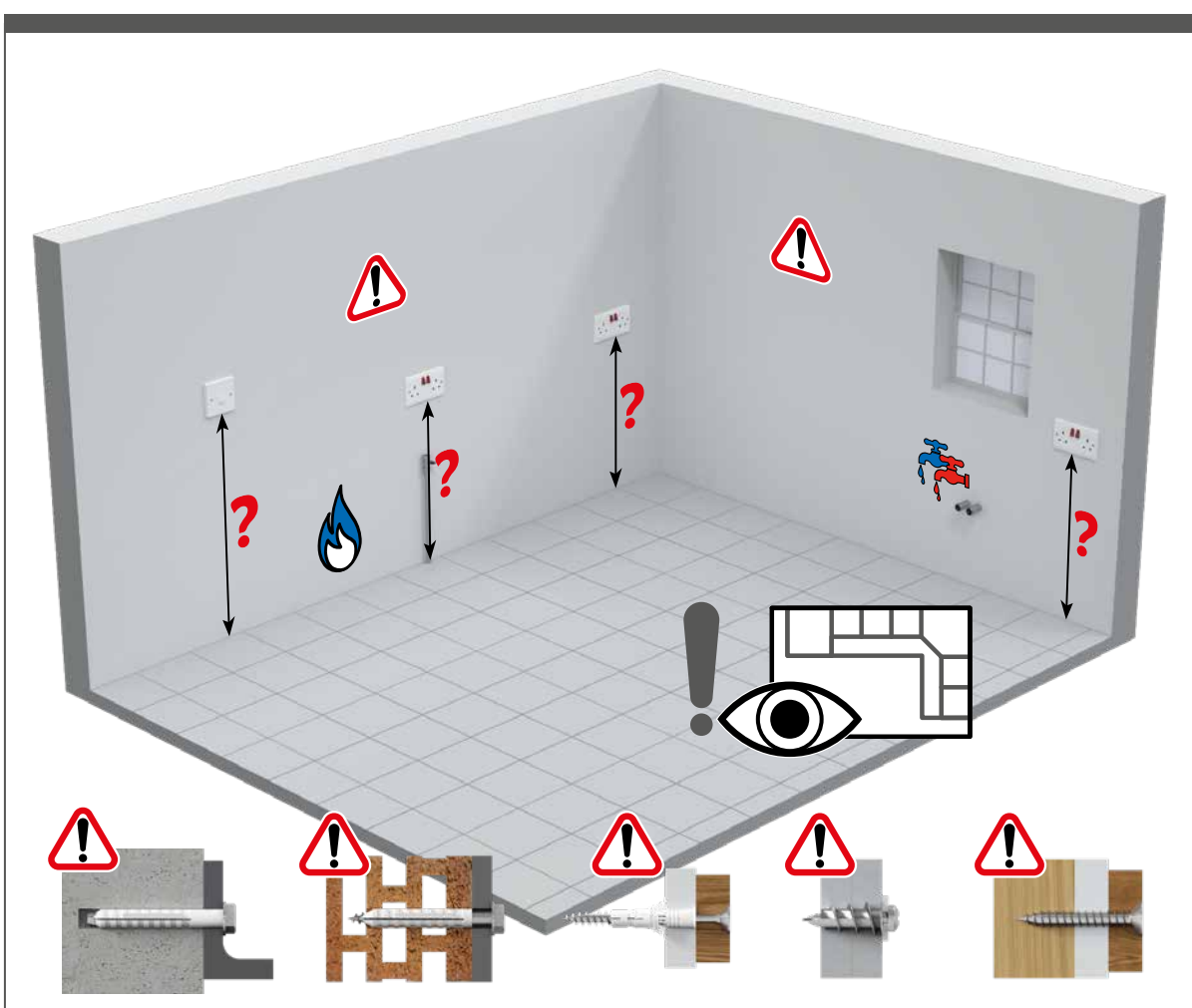
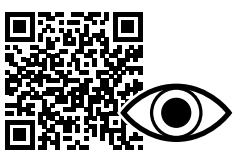

2a

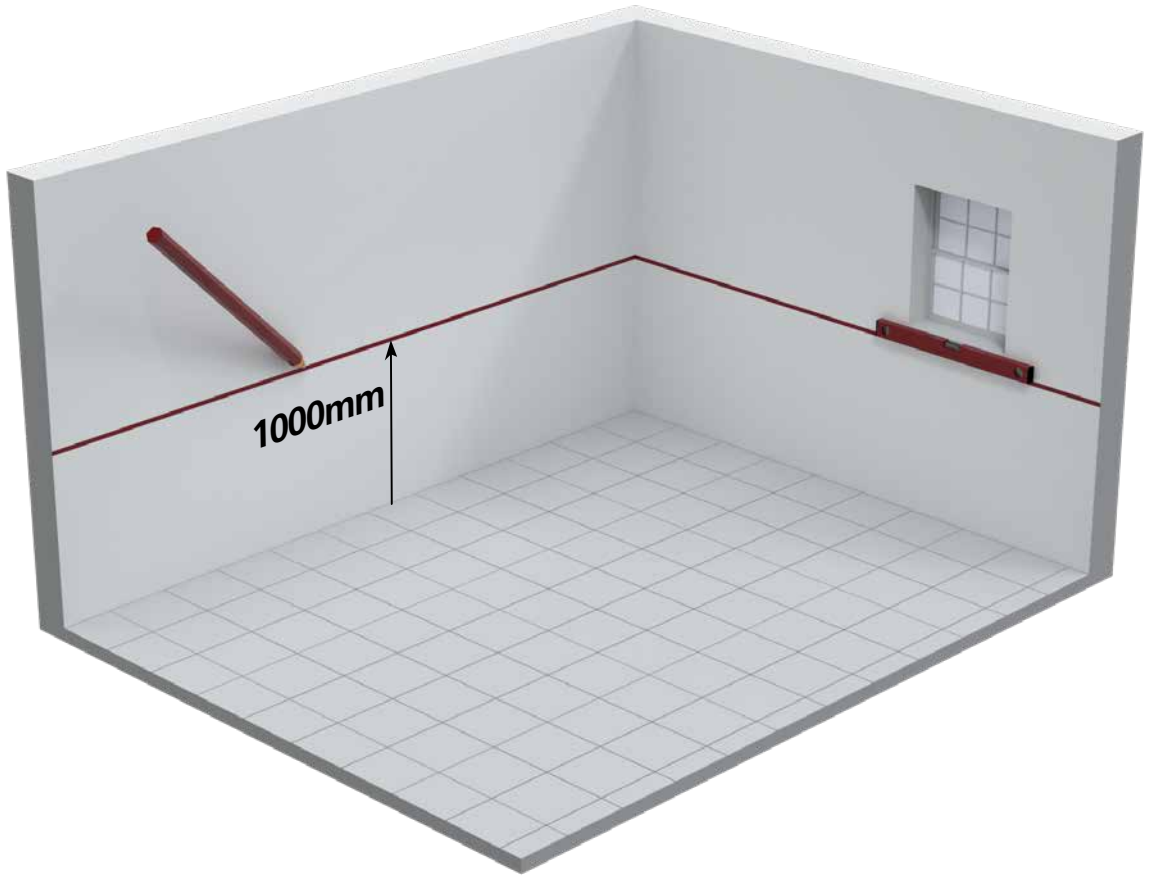

Note: Not all floors are even so before starting the installation, follow the stages as a guide.

Stage 2a: Mark a point on any wall **1000mm** from the floor and using a spirit level mark a datum line around the walls.

2b

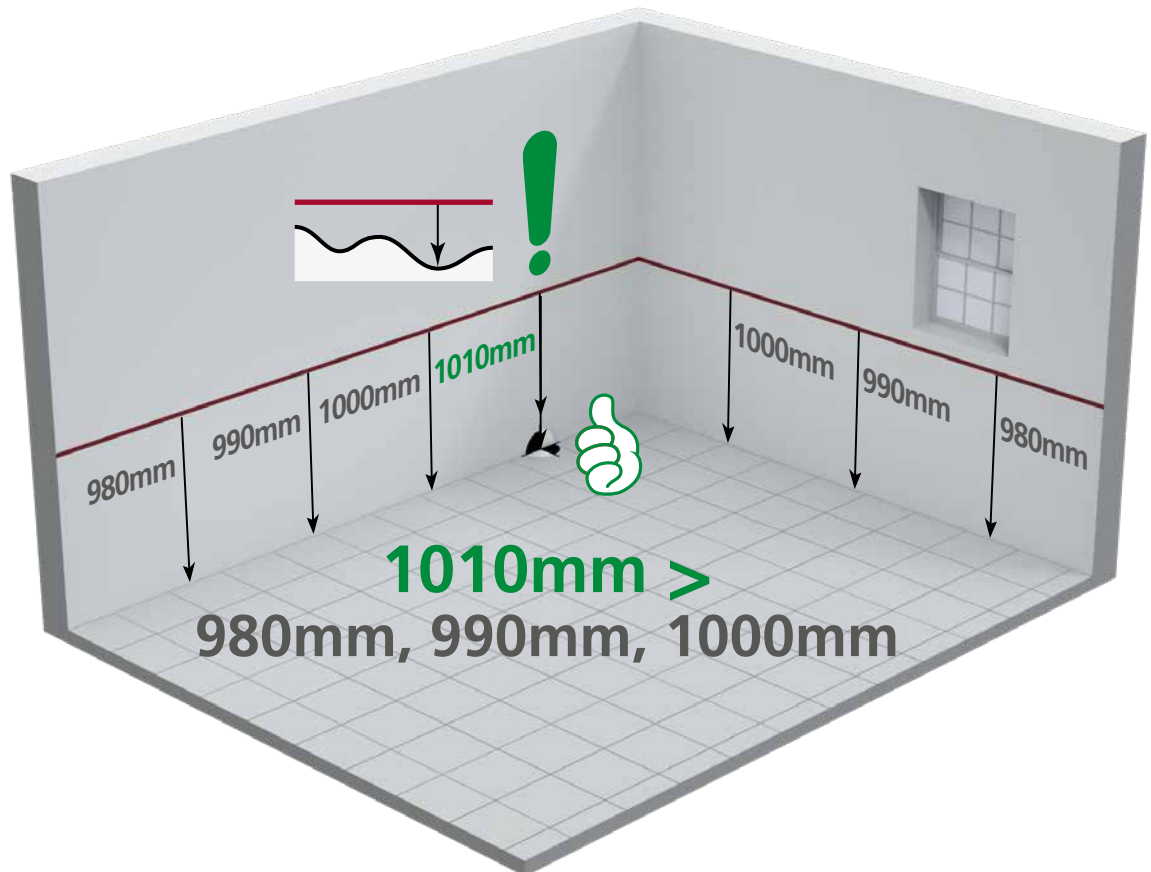

Stage 2b: Measure down from the 'Stage 2a' datum line at various points to establish the lowest point on the floor. This will be the largest measurement.

2c →

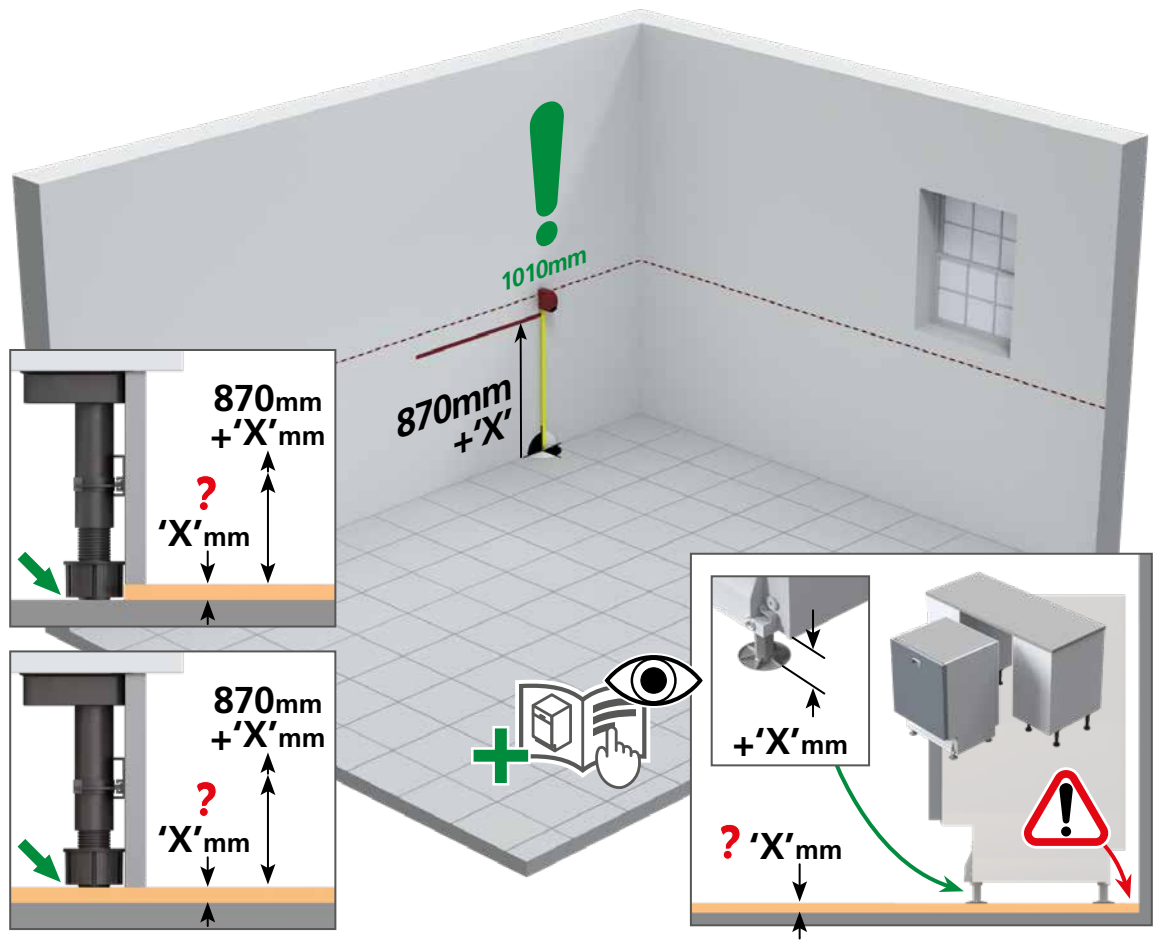

Stage 2c: From the lowest point marked in 'Stage 2b', measure 870mm + 'X', (floor covering), up the wall.

2d →

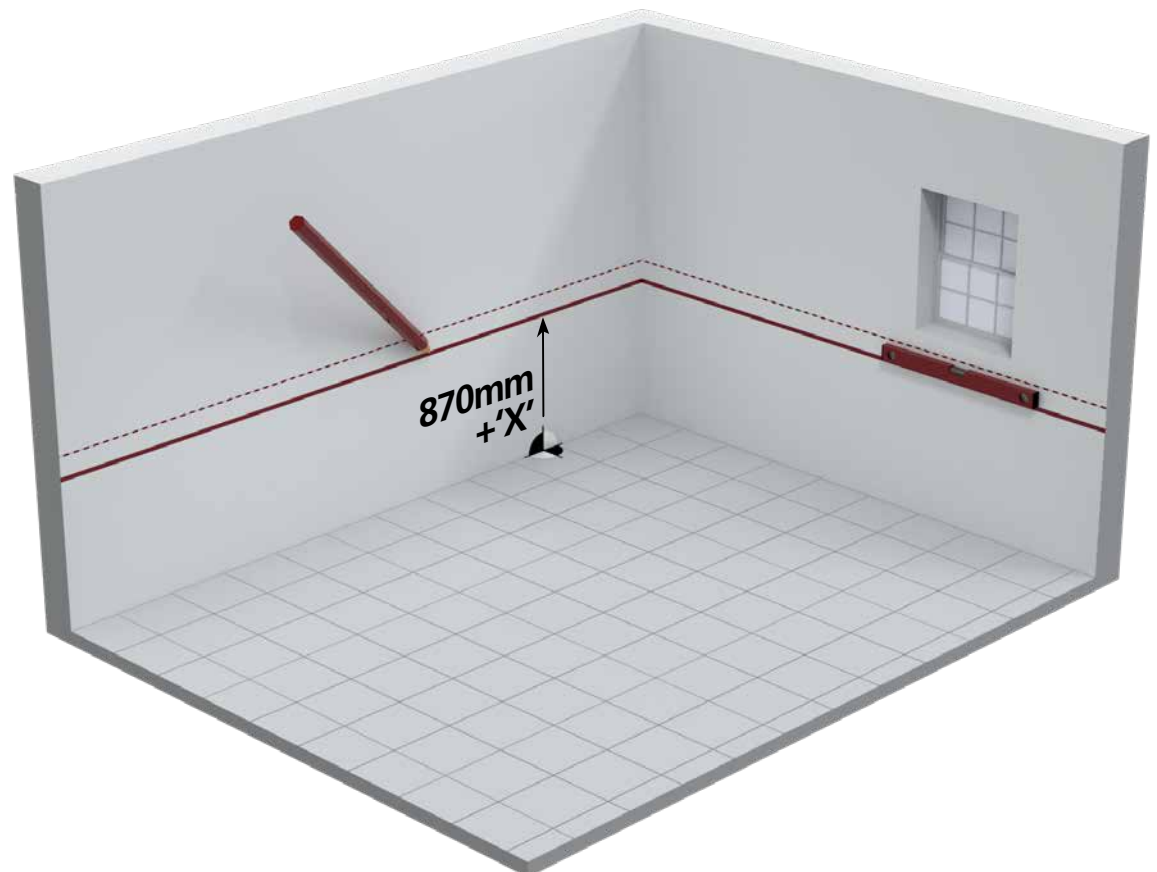

Stage 2d: Using a spirit level, mark the 870mm + 'X' datum line around the walls.

2e →

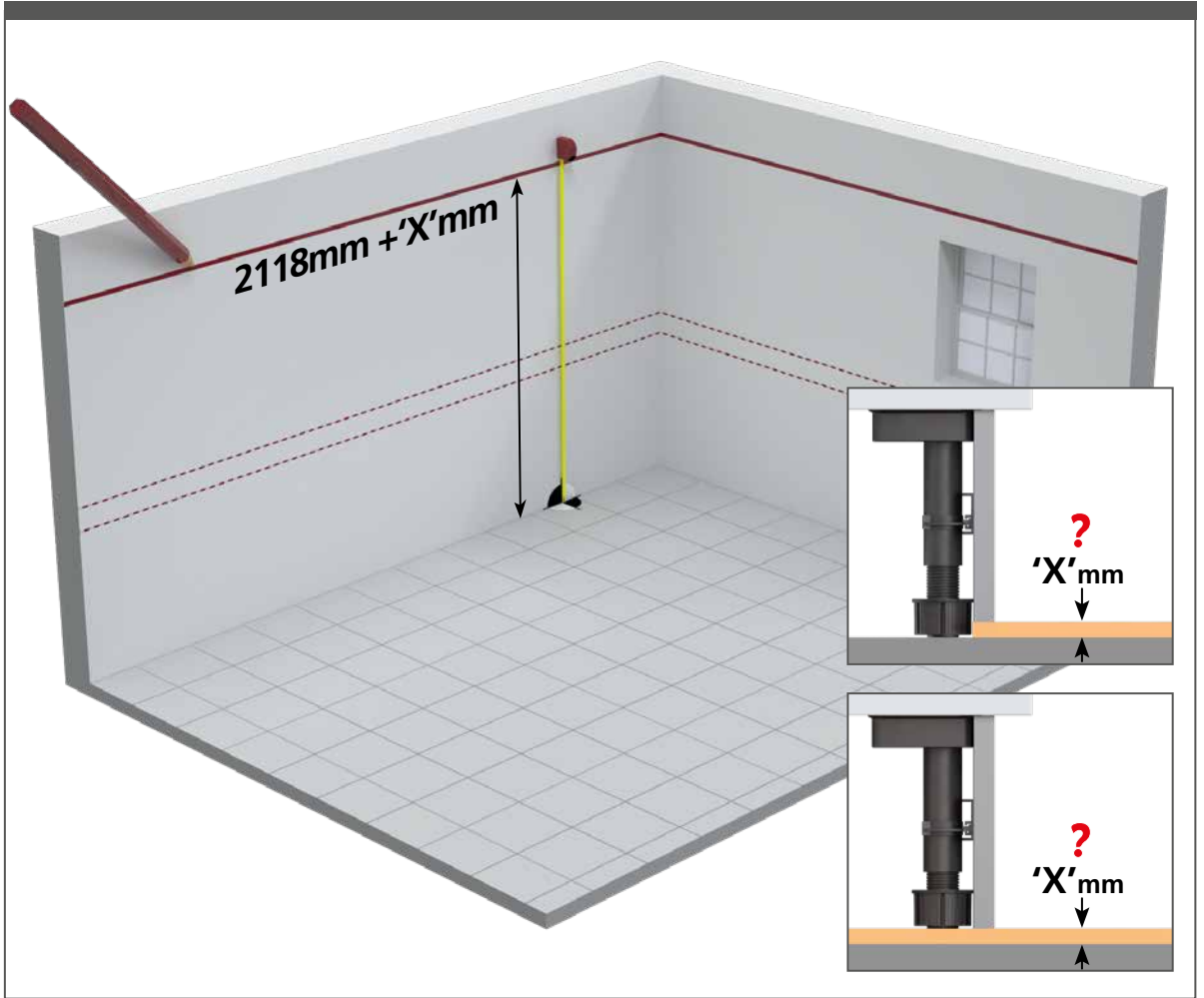
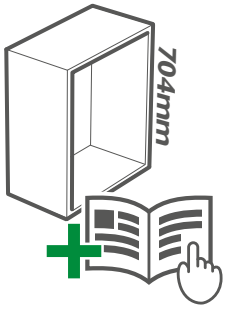

Stage 2e: From the lowest point marked, measure **2118mm + 'X'** for **704mm Standard Wall** units and mark the upper datum line.

2f →

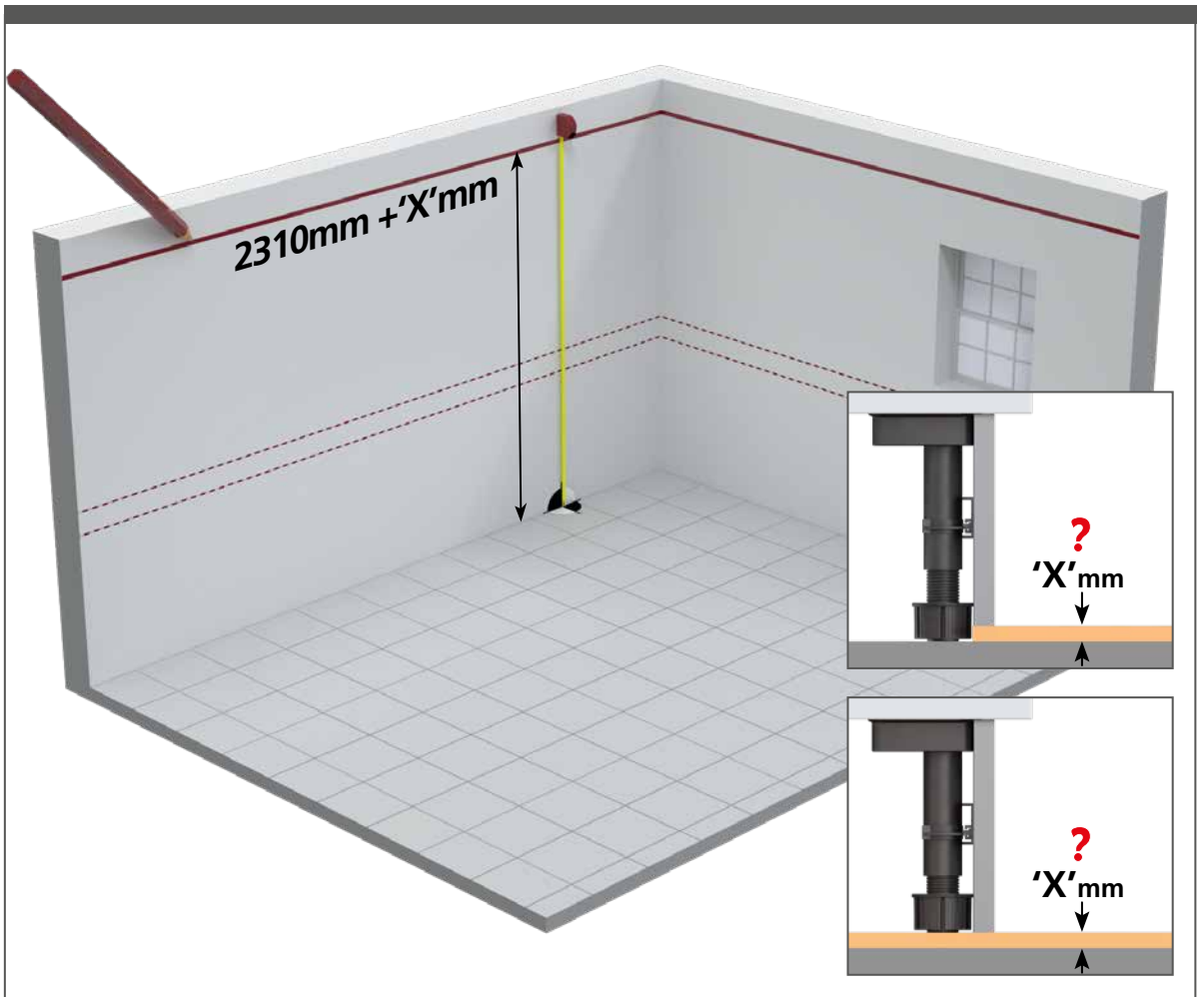
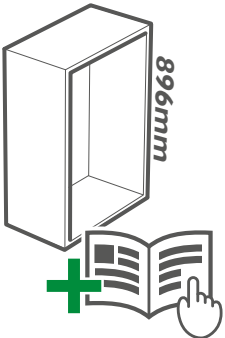

Stage 2f: From the lowest point marked, measure **2310mm + 'X'** for **896mm Tall Wall** units and mark the upper datum line.

Note: Minimum overall ceiling height required when fitting **896mm Tall Wall** units in conjunction with **Tall Larder** units is **2310mm**. **This does not allow for the fitting of a cornice.**

2g →

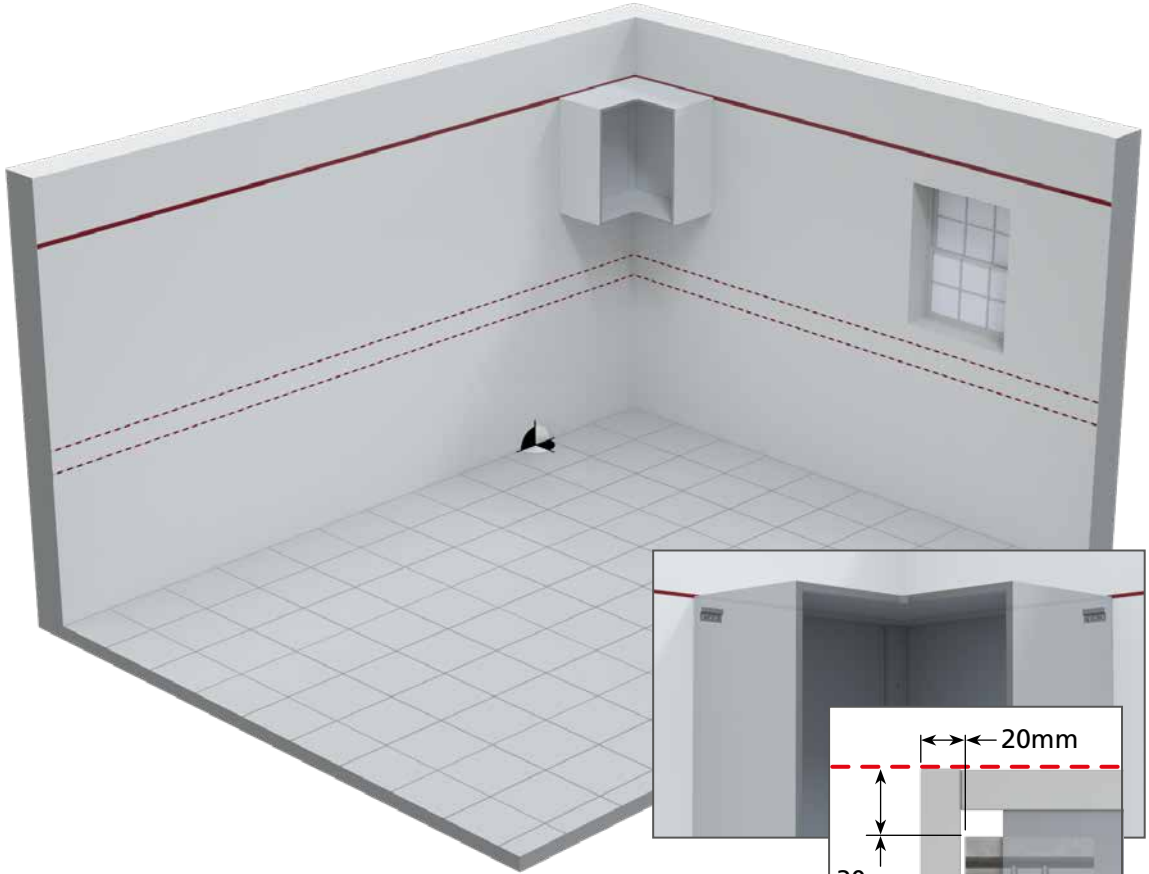
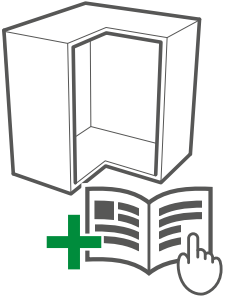

Stage 2g: From the upper datum line, position the hanging brackets **30mm** below and **20mm** in from the outer edges of the unit. Hang the wall unit.
Generic unit illustrated, other units similar.

2h →

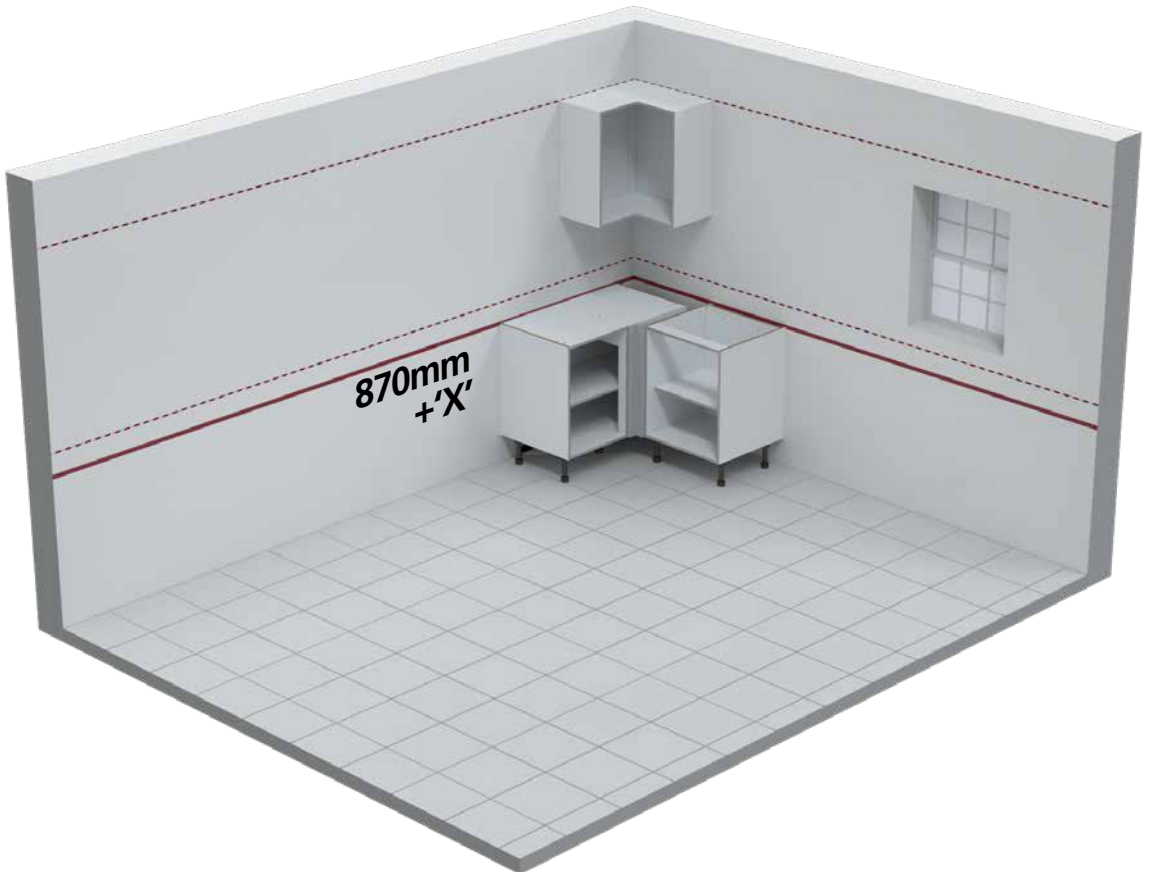

Stage 2h: Position the corner base unit.
Generic unit illustrated, other units similar.

2i →

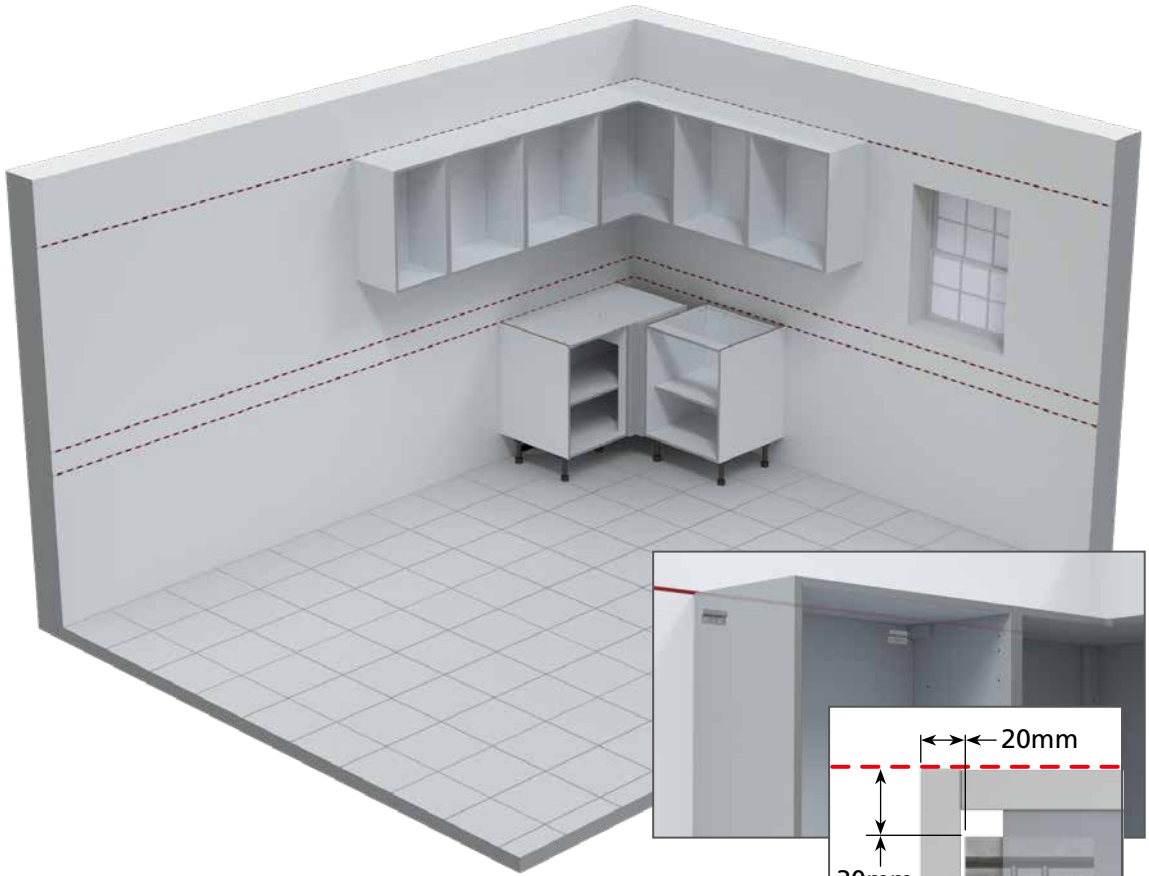
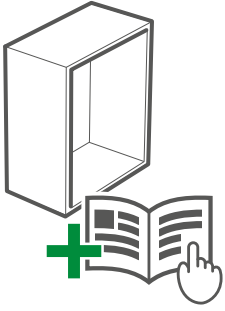

Stage 2i: From the upper datum line, position the hanging brackets **30mm** below and **20mm** in from the outer edges of the units. Hang the wall units. *Generic units illustrated, other units similar.*

2j →

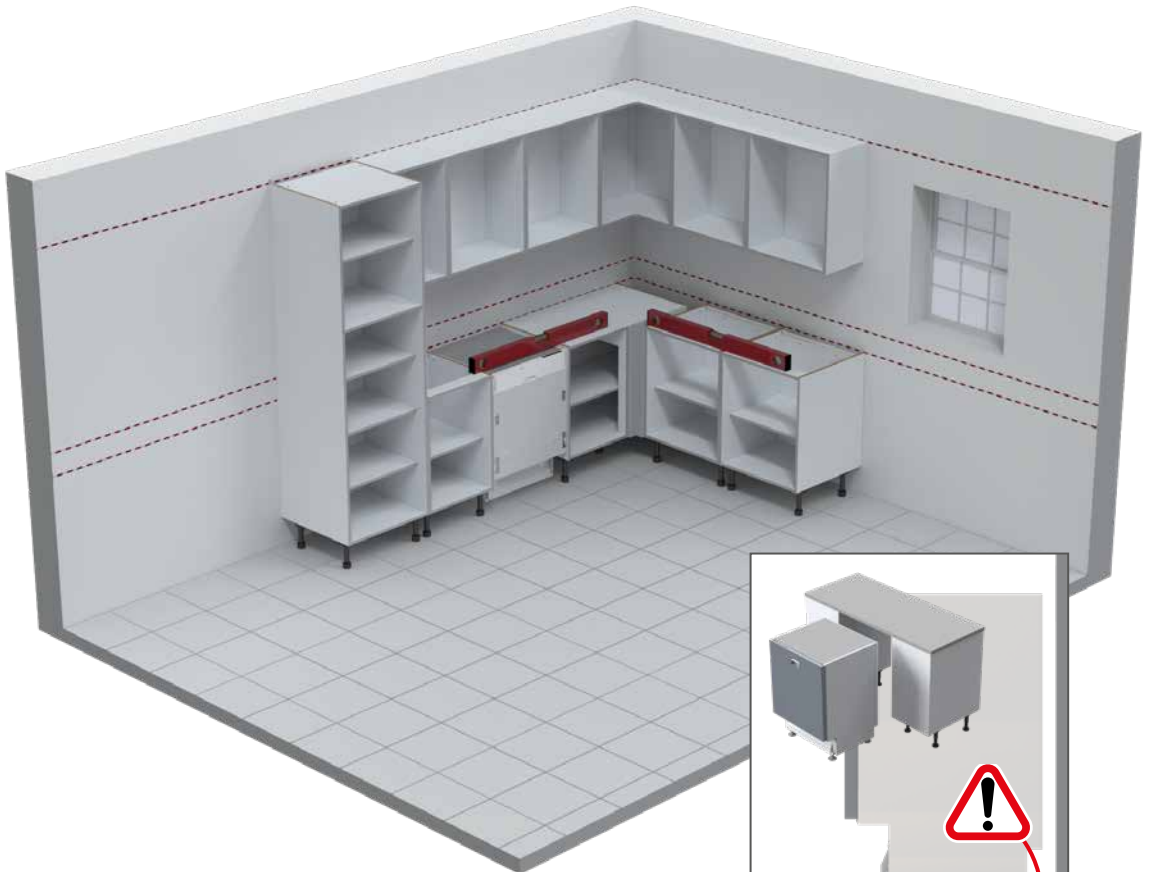

Stage 2j: Position larder/appliance units as required and attach to the wall.

3a



'L' Corner Base Unit

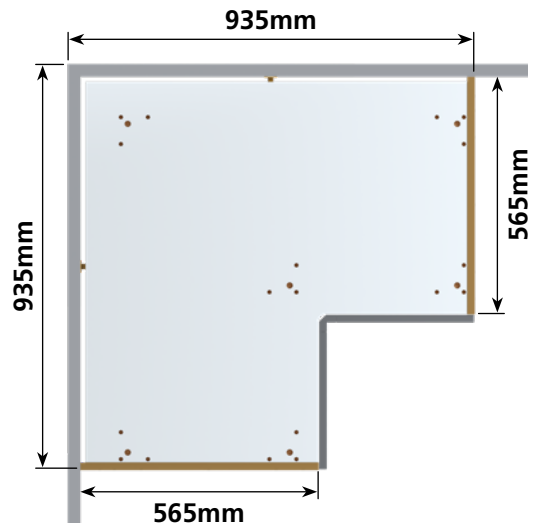

3b



Door opening and connecting Corner Base Unit



A	B (door)	C
800mm	396mm	935mm
800mm	496mm	1135mm
1000mm	446mm	1085mm
1000mm	496mm	1135mm
1000mm	596mm	1235mm

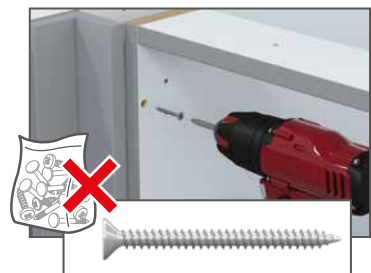
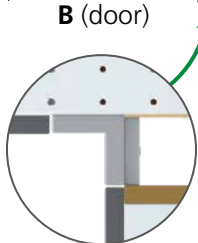
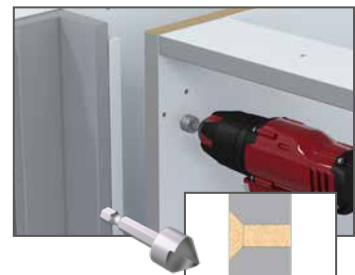
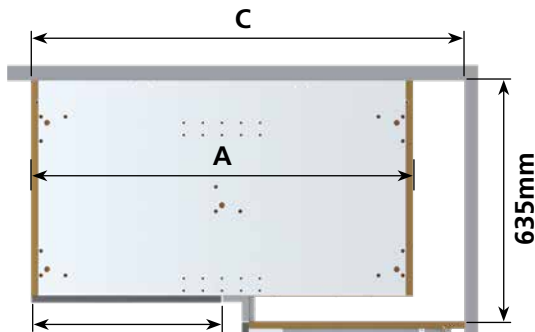
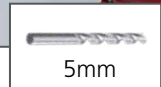
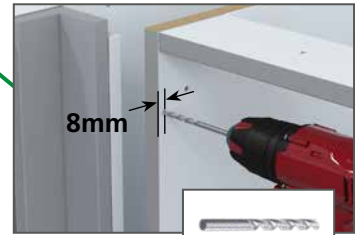

4a →

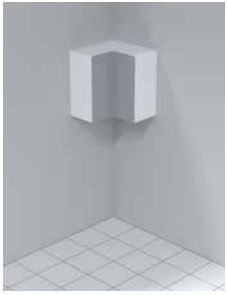

'L' Corner Wall Unit

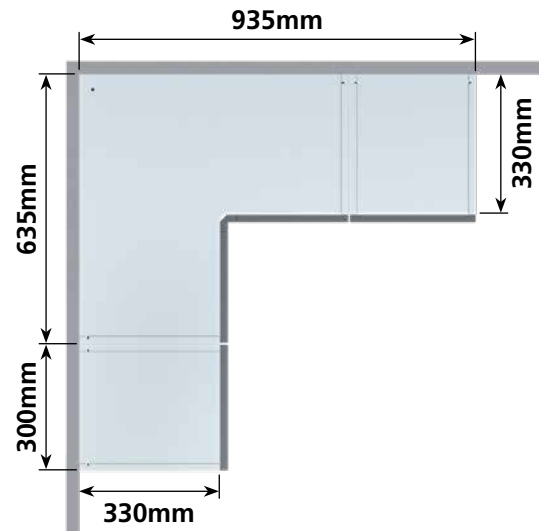
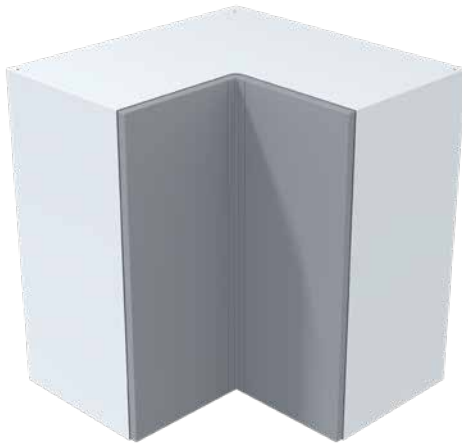

4b →

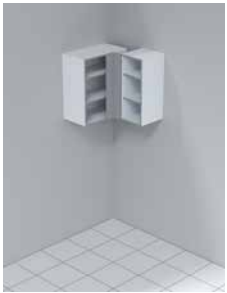

Door opening and connecting Corner Wall Unit



A	B (door)	C
600mm	296mm	700mm
600mm	396mm	800mm
800mm	396mm	800mm

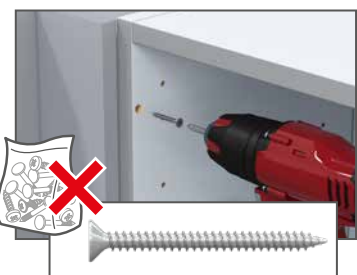
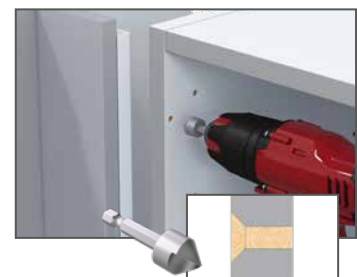
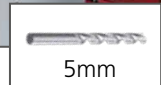
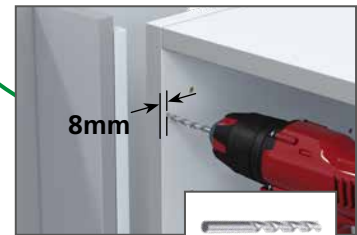
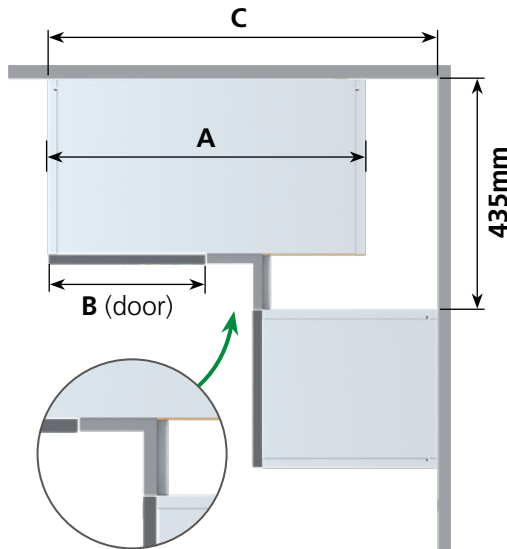

5a →

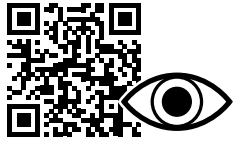

Attaching legs

6a →



Fitting plinths

Front plinth

Return plinth

7a →

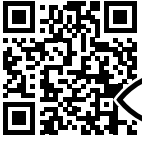

Attaching to wall

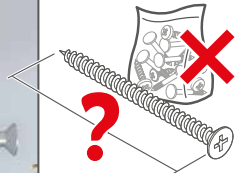
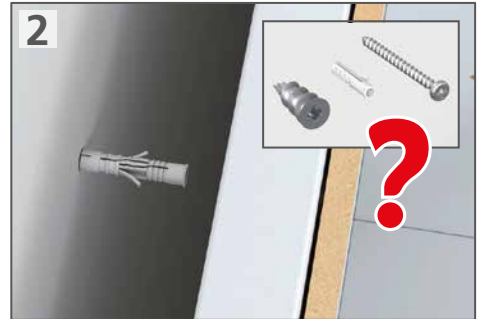

Note: Wall fixing screws are not supplied due to different wall types requiring different fixings.

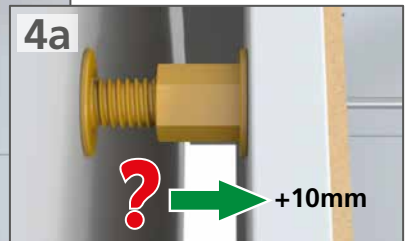

8a →



Connecting units

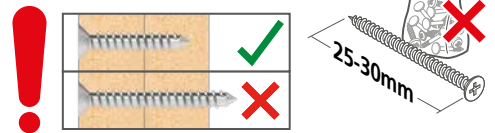

9a →



Filler and end panels

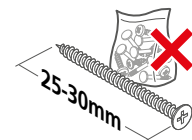
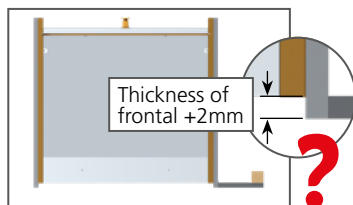
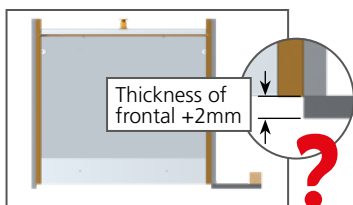
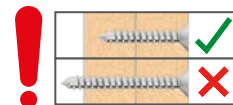
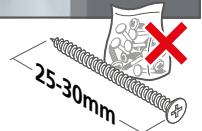
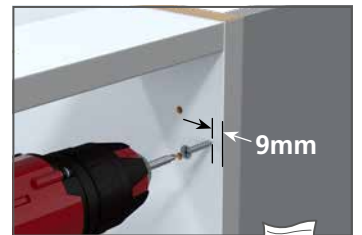
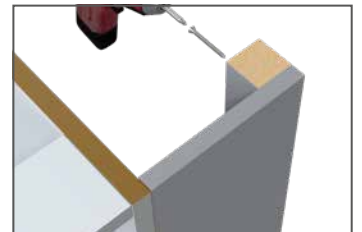

10a



Starting a unit run from a wall



Starting a unit run from a wall

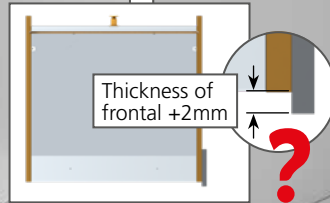
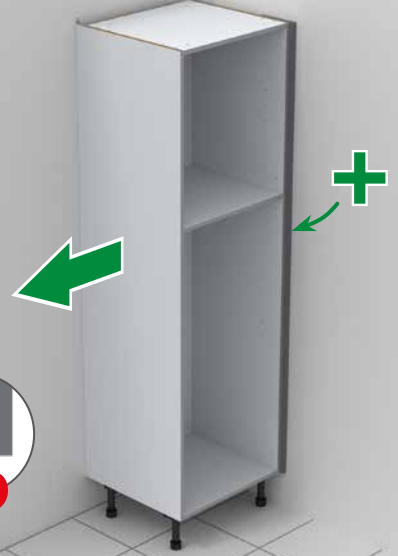

11a



Handle fitting

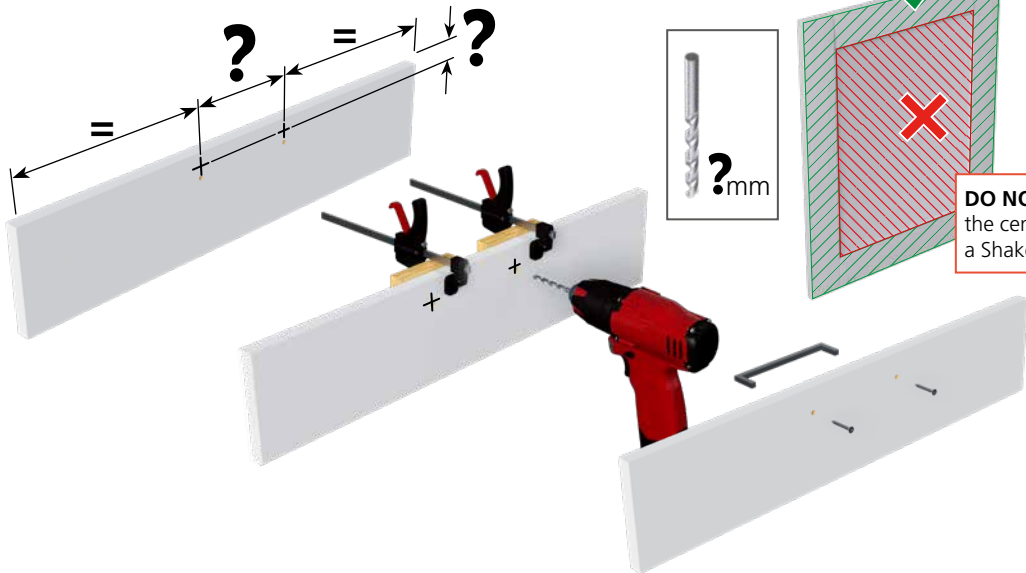

12a

Cornice and pelmet fitting

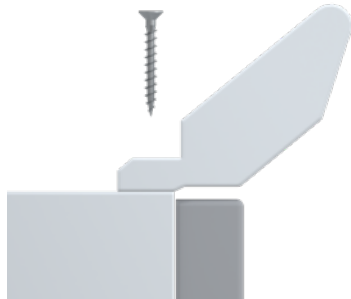

Cornice Profile 1
To only be used on the **TOP** of units.



Trim 27 Profile 1
Can be used top or bottom.

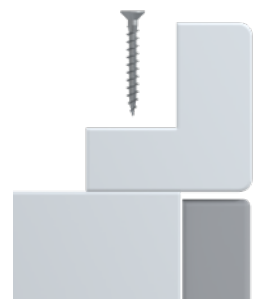

Trim 27 L Shape
Can be used top or bottom.

Note: It is recommended that this should be undertaken by a competent joiner or fitter. Mark and drill the holes for fixing the cornice onto the run of cabinets, for stability it is recommended a minimum of **3** fixings per **2.7m** run. Screw fixing position highlighted above.

13a

Frontal fitting - Tandembox



Attach drawer frontal brackets, see frontal dimensions

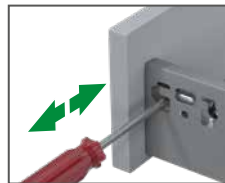
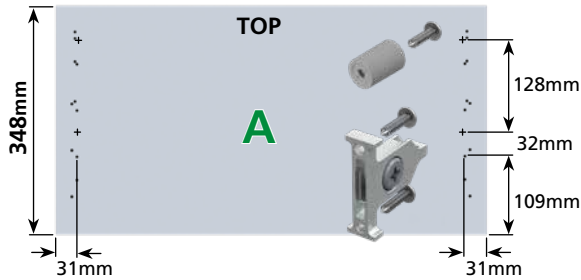
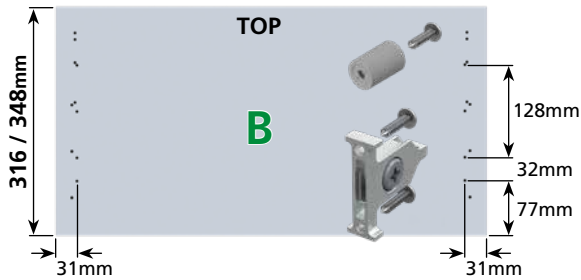
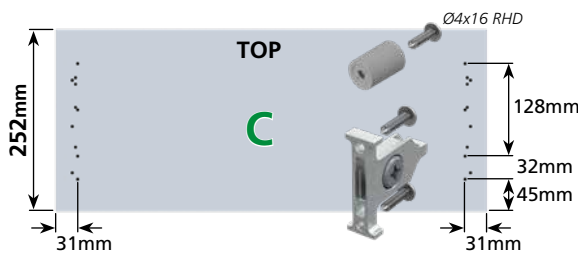
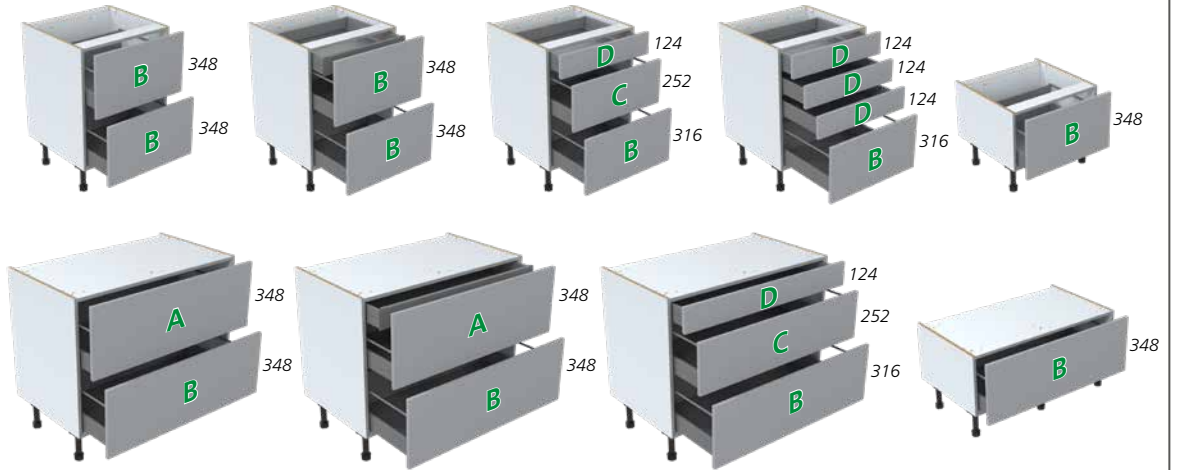

Drawer frontal adjustment

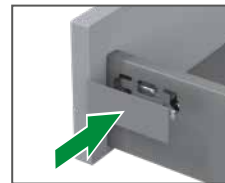

Fit cover cap

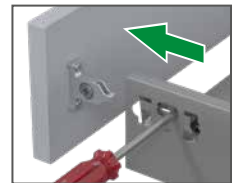

Remove drawer frontal

14a

Frontal fitting - Metabox



Attach drawer frontal brackets, see frontal dimensions

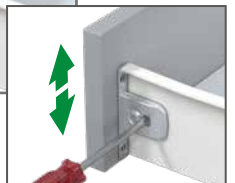
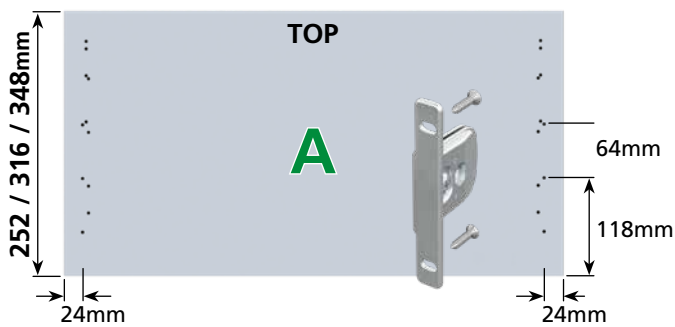
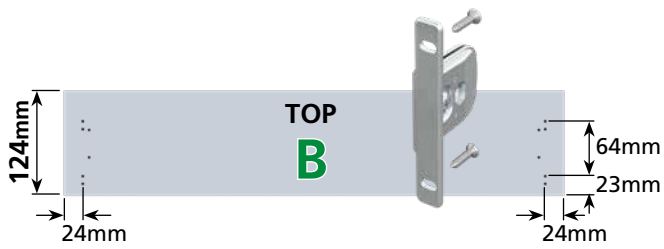
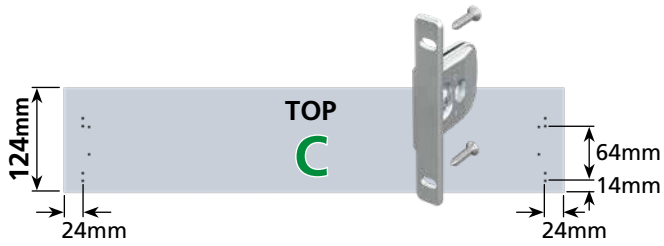
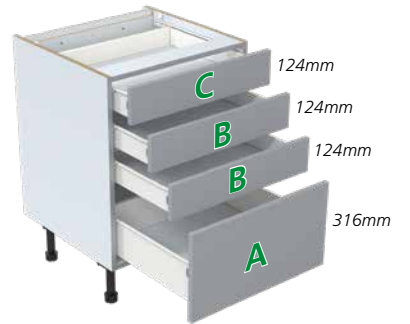
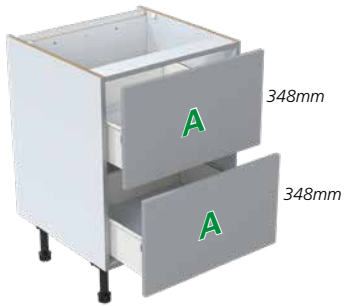
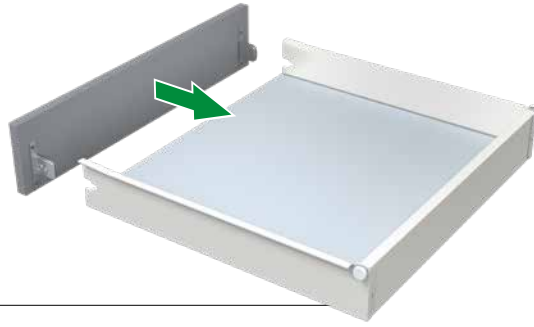

Drawer frontal adjustment

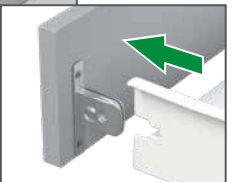
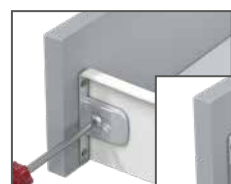

Remove drawer frontal

